

EUROsystem 2 x 3, curved

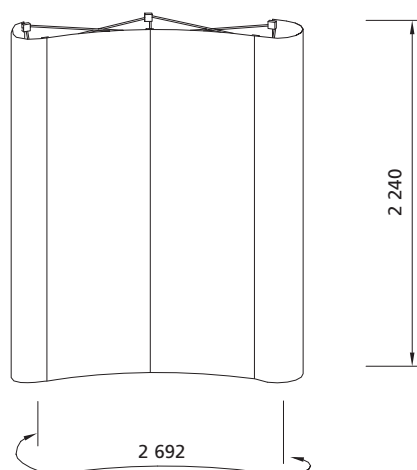

Graphic dimensions

Total size: 2 692 x 2 240 mm

Front panel dimension: 673 x 2 240 mm

Side panel dimension: 673 x 2 240 mm

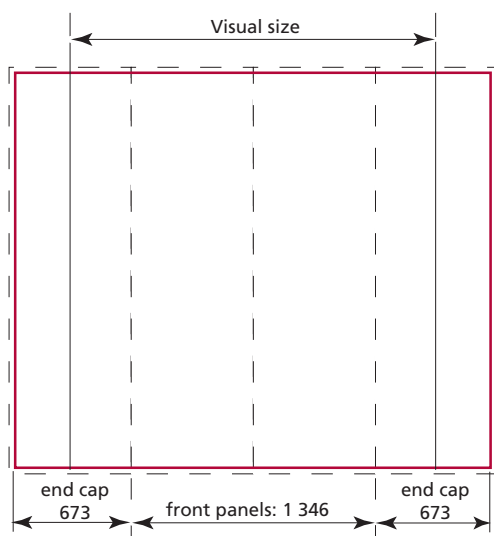

Graphic preparation

Entire format: 2 692x 2 240 mm

Printing area: 2 732 x 2 280 mm

Overlap: 20 mm on each side of entire format
WITHOUT CUTTING MARKS

Data requirements for digital print:

PDF:

Adobe Acrobat (version 6 and lower)
Texts integrated into the file or converted into paths.

Bitmap applications:

TIFF, BMP, EPS, Photoshop – PSD (version 8 and lower).

All data must be prepared on a 1:1 scale. Pictures on a scale of 1:4 or larger (up to 1:1) scanned in with 320 dpi (physical resolution).

Vector applications:

Illustrator – EPS nebo AI (version 11 and lower)
Logos and texts must be converted into paths.

Other applications after consultation.

Colours:

All data have to be in CMYK (be aware of fotos in RGB and direct colours in Illustrator) and must have defined the used colour profile. Otherwise we do not guarantee desired colours.

Possible data compression:

ZIP, ARJ, RAR, Stuffit

Data media:

CD, DVD, external USB, HD, data transfer through FTP

Other media after consultation.