

EUROtower 1, square

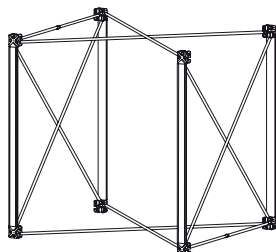

Art nr.: 2.50.11001
 Weight: 1,8 kg
 Material: aluminium alloy, eloxed

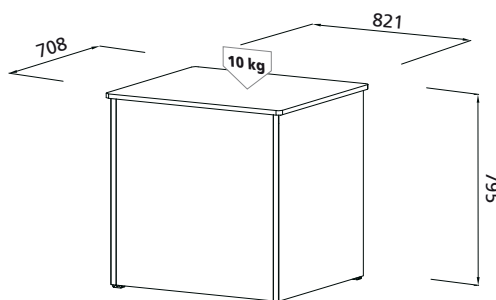

Art nr.: 2.51.02001
 Weight: 5,5 kg
 Material: laminated chipboard

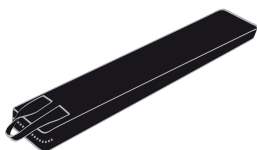

Art nr.: 2.11.07103-01
 Weight: 0,24 kg
 Material: nylon
 Dimensions: 150 x 50 x 730 mm



Art nr.: 2.51.07011-01
 Weight: 1,05 kg
 Material: nylon
 Dimensions: 826 x 30 x 710 mm

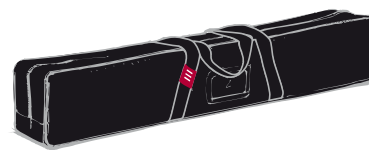

Art nr.: 2.51.07001-01
 Weight: 1,86 kg
 Material: nylon, foam filling
 Dimensions: 100 x 12 x 18 cm

Art nr.	Description
2.50.11001	EUROtower 1, square including magnetic bars
2.51.02001	Top desk for ET, square
2.51.07001-01	Flight bag for ET, square, black
2.11.07103-01	Transport bag for straight mag. bars, max of 21 bars, black
2.51.07011-01	Transport bag square, black

Graphic panels for ET - 1, square

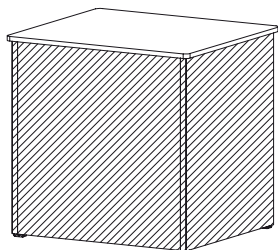

Art nr.: 2.53.11001-01
 Weight: 1,28 kg
 Material: PE

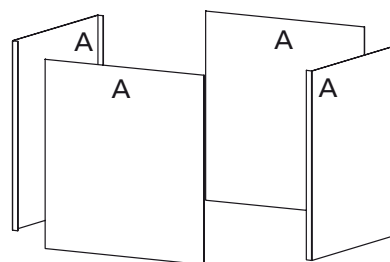

A: 733 x 774 mm

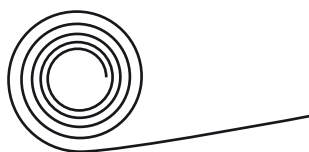

Art nr.: 2.12.00230
 Material: adhesive magnetic tape
 Colour: black

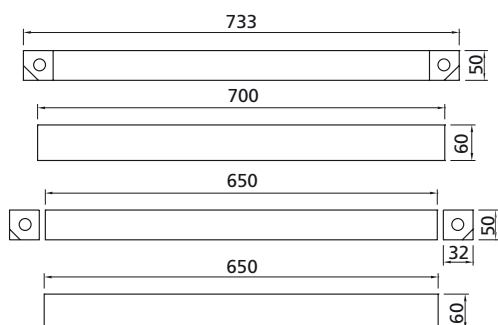

Art nr.: 2.52.09111

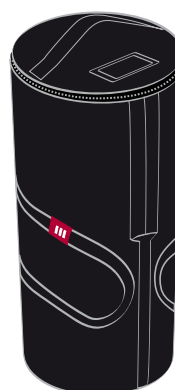

Art nr.: 2.11.07102-01
 Weight: 2,48 kg
 Material: nylon, polyethylen

Art nr.	Description
2.53.11001-01	Set of fully equipped graphic panels for ET - 1, square, incl. print
2.52.09111	Set of hangers and kickers for panels for ET square
2.11.07102-01	Flight bag for graphics, black
2.12.00230	Magnetic tape for panels, 30 m coil, magnetised A, Origin: EU

EUROtower 2, square

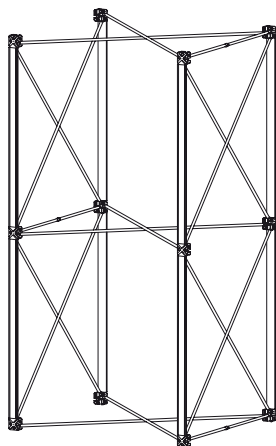

Art nr.: 2.50.12001
Weight: 3,6 kg
Material: aluminium alloy, eloxed

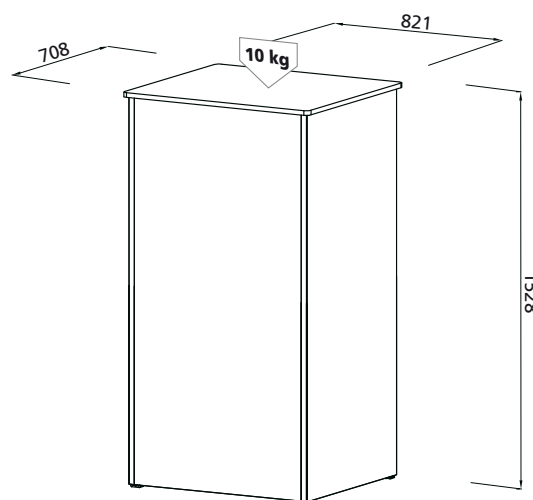

Art nr.: 2.51.02001
Weight: 5,5 kg
Material: laminated chipboard

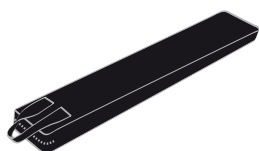

Art nr.: 2.11.07103-01
Weight: 0,24 kg
Material: nylon
Dimensions: 150 x 50 x 730 mm



Art nr.: 2.51.07011-01
Weight: 1,05 kg
Material: nylon
Dimensions: 826 x 30 x 710 mm

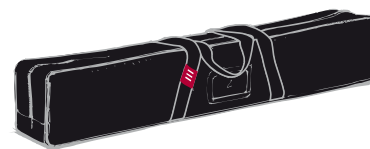

Art nr.: 2.51.07001-01
Weight: 1,86 kg
Material: nylon, foam filling
Dimensions: 100 x 12 x 18 cm

Art nr.	Description
2.50.12001	EUROtower 2, square including magnetic bars
2.51.02001	Top desk for ET, square
2.51.07001-01	Flight bag for ET, square, black
2.11.07103-01	Transport bag for straight mag. bars, max of 21 bars, black
2.51.07011-01	Transport bag square, black

Graphic panels for ET - 2, square

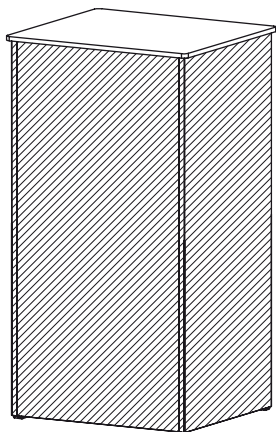

Art nr.: 2.53.12001-01
Weight: 2,52 kg
Material: PE

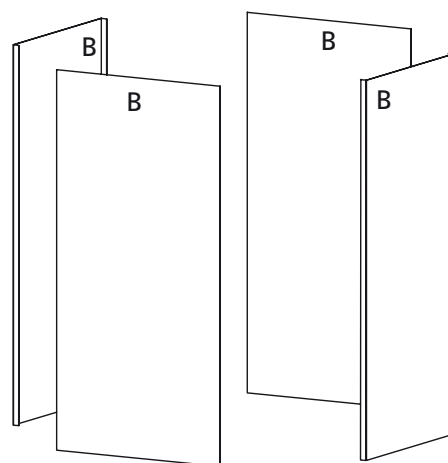

B: 733 x 1507 mm



Art nr.: 2.12.00230
Material: adhesive magnetic tape
Colour: black

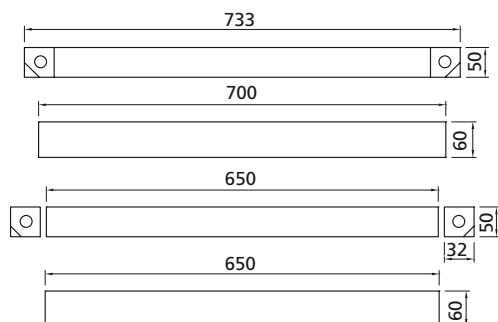

Art nr.: 2.52.09111

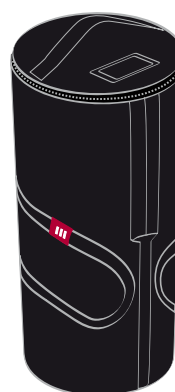

Art nr.: 2.11.07102-01
Weight: 2,48 kg
Material: nylon, polyethylen

Art nr.	Description
2.53.12001-01	Set of fully equipped graphic panels for ET - 2, square, incl. print
2.52.09111	Set of hangers and kickers for panels for ET square
2.11.07102-01	Flight bag for graphics, black
2.12.00230	Magnetic tape for panels, 30 m coil, magnetised A, Origin: EU

EUROtower 3, square

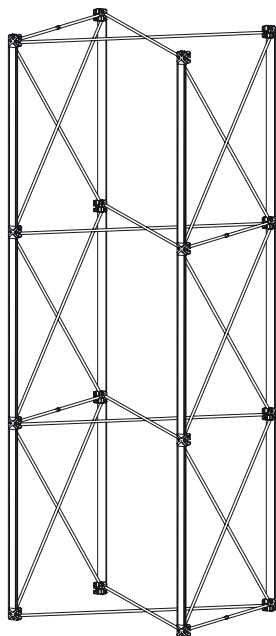

Art nr.: 2.50.13001
 Weight: 5,3 kg
 Material: aluminium alloy, eloxed

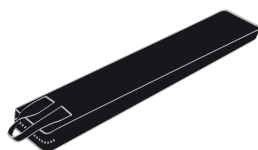
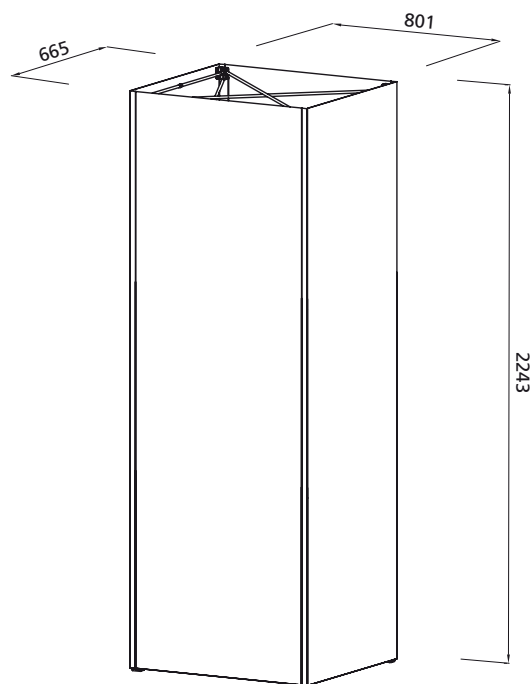

Art nr.: 2.11.07103-01
 Weight: 0,24 kg
 Material: nylon
 Dimensions: 150 x 50 x 730 mm

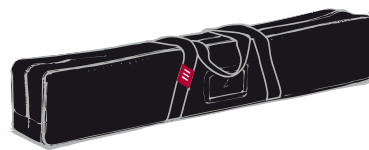

Art nr.: 2.51.07001-01
 Weight: 1,86 kg
 Material: nylon, foam filling
 Dimensions: 100 x 12 x 18 cm

Art nr.	Description
2.50.13001	EUROtower 3, square including magnetic bars
2.51.07001-01	Flight bag for ET, square, black
2.11.07103-01	Transport bag for straight mag. bars, max of 21 bars, black

Graphic panels for ET - 3, square

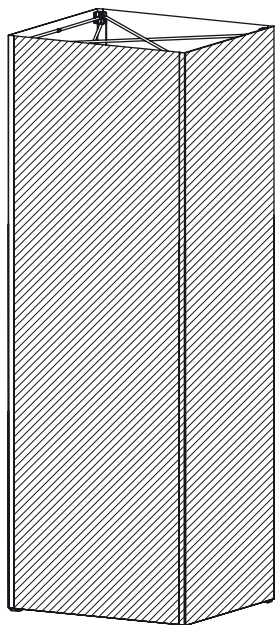

Art nr.: 2.53.13001-01
Weight: 3,76 kg
Material: PE

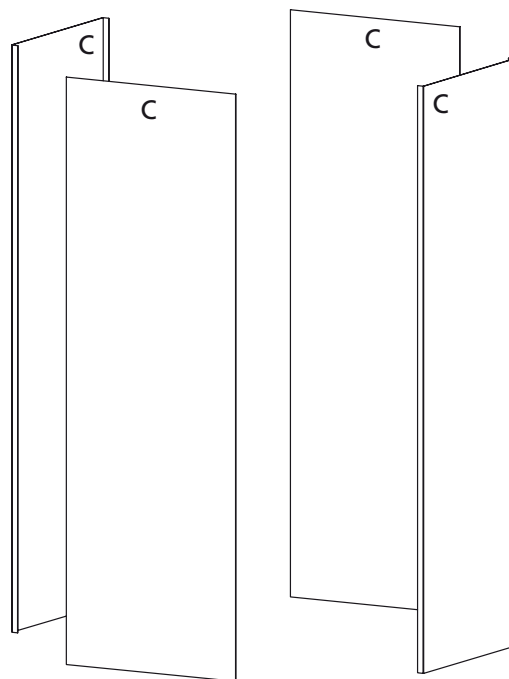

C: 733 x 2240 mm



Art nr.: 2.12.00230
Material: adhesive magnetic tape
Colour: black

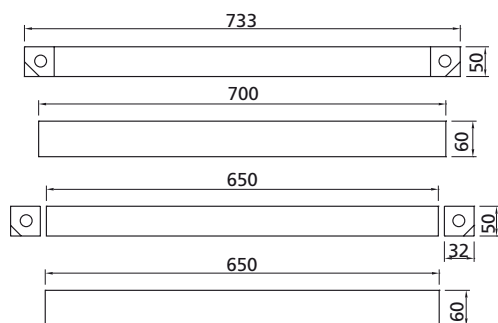

Art nr.: 2.52.09111

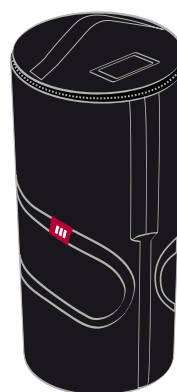

Art nr.: 2.11.07102-01
Weight: 2,48 kg
Material: nylon, polyethylen

Art nr.	Description
2.53.13001-01	Set of fully equipped graphic panels for ET - 3, square, incl. print
2.52.09111	Set of hangers and kickers for panels for ET square
2.11.07102-01	Flight bag for graphics, black
2.12.00230	Magnetic tape for panels, 30 m coil, magnetised A, Origin: EU

EUROtower 4, square

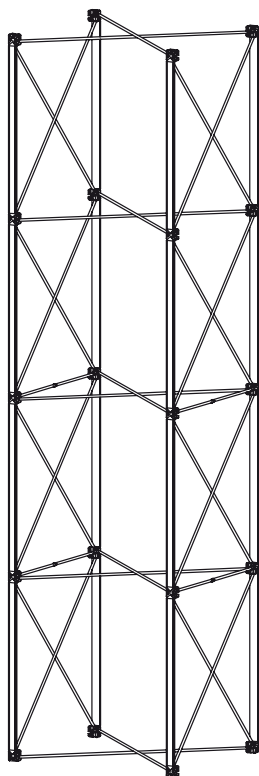

Art nr.: 2.50.14001
 Weight: 6,9 kg
 Material: aluminium alloy, eloxed

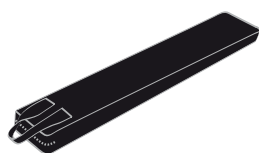
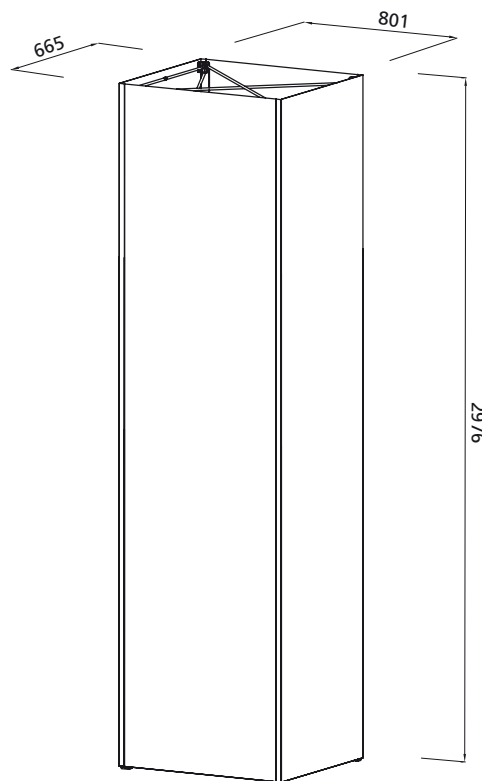

Art nr.: 2.11.07103-01
 Weight: 0,24 kg
 Material: nylon
 Dimensions: 150 x 50 x 730 mm

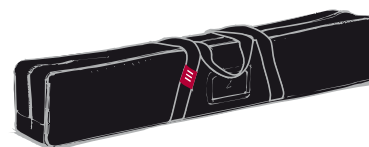

Art nr.: 2.51.07001-01
 Weight: 1,86 kg
 Material: nylon, foam filling
 Dimensions: 100 x 12 x 18 cm

Art nr.	Description
2.50.14001	EUROtower 4, square including magnetic bars
2.51.07001-01	Flight bag for ET, square, black
2.11.07103-01	Transport bag for straight mag. bars, max of 21 bars, black

Graphic panels for ET - 4, square

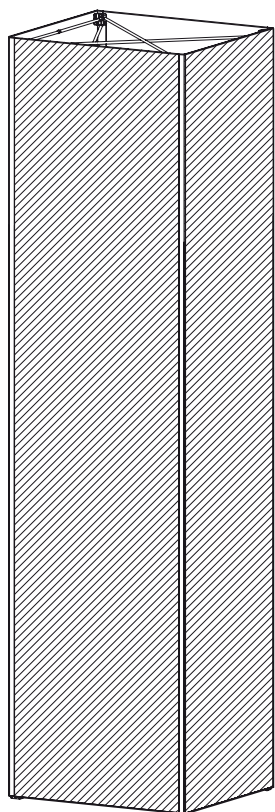

Art nr.: 2.53.14001-01
Weight: 5,12 kg
Material: PE



Art nr.: 2.12.00230
Material: adhesive magnetic tape
Colour: black

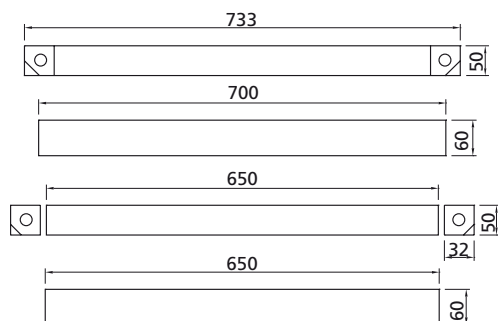

Art nr.: 2.52.09111

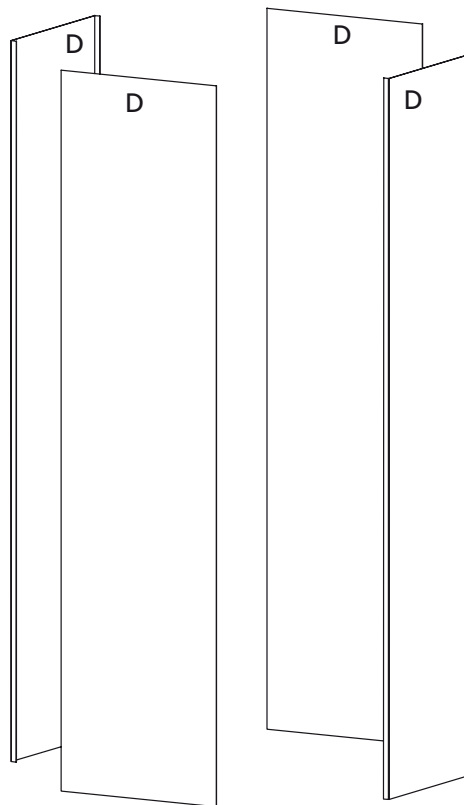

D: 733 x 2973 mm

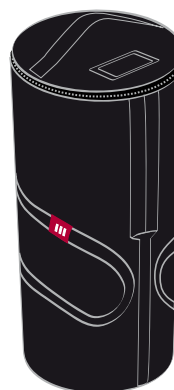

Art nr.: 2.11.07102-01
Weight: 2,48 kg
Material: nylon, polyethylen

Art nr.	Description
2.53.14001-01	Set of fully equipped graphic panels for ET - 4, square, incl. print
2.52.09111	Set of hangers and kickers for panels for ET square
2.11.07102-01	Flight bag for graphics, black
2.12.00230	Magnetic tape for panels, 30 m coil, magnetised A, Origin: EU

EUROtower 1, round

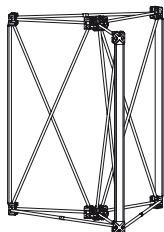

Art nr.: 2.50.11002
 Weight: 2,06 kg
 Material: aluminium alloy, eloxed

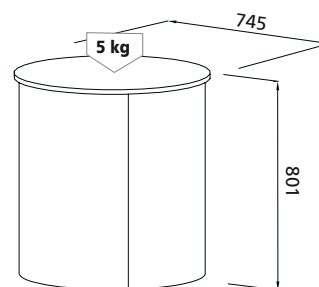

Art nr.: 2.51.02002
 Weight: 5,3 kg
 Material: laminated chipboard

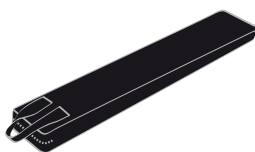

Art nr.: 2.11.07103-01
 Weight: 0,24 kg
 Material: nylon
 Dimensions: 150 x 50 x 730 mm



Art nr.: 2.51.07012-01
 Weight: 0,95 kg
 Material: nylon
 Dimensions: Ø 800 x 30 mm



Art nr.: 2.11.07130-01
 Weight: 1,9 kg
 Material: nylon, polypropylen,
 foam filling
 Dimensions: 270 x 230 x 850 mm

Art nr.	Description
2.50.11002	EUROtower 1, round including magnetic bars
2.51.02002	Top desk for ET, round
2.11.07130-01	Flight bag for structure, size, black
2.11.07103-01	Transport bag for straight mag. bars, max. of 21 bars, black
2.51.07012-01	Transport bag round, black

Graphic panels for ET - 1, round

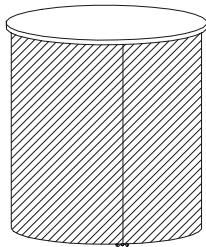

Art nr.: 2.53.11002-01
Weight: 0,96 kg
Material: PE

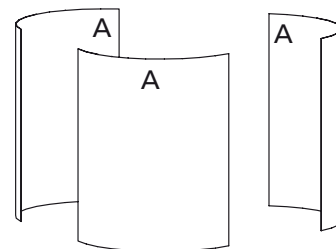

A: 733 x 774 mm



Art nr.: 2.12.00230
Material: adhesive magnetic tape
Colour: black

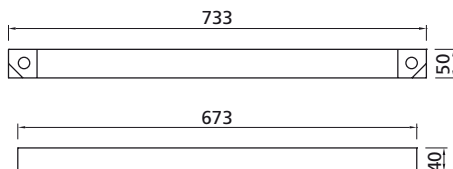

Art nr.: 2.52.09112

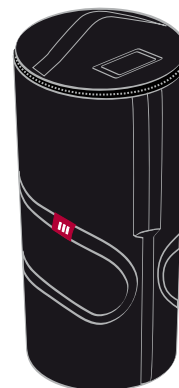

Art nr.: 2.11.07102-01
Weight: 2,48 kg
Material: nylon, polyethylen

Art nr.	Description
2.53.11002-01	Set of fully equipped graphic panels for ET - 1, round, incl. print
2.52.09112	Set of hangers and kickers for panels for ET square
2.11.07102-01	Flight bag for graphics, black
2.12.00230	Magnetic tape for panels, 30 m coil, magnetised A, Origin: EU

EUROtower 2, round

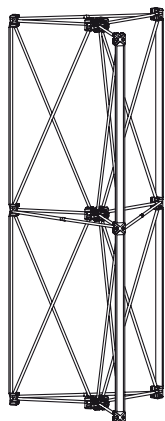

Art nr.: 2.50.12002
Weight: 3,6 kg
Material: aluminium alloy, eloxed

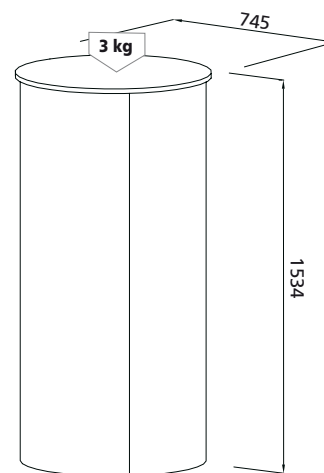

Art nr.: 2.51.02002
Weight: 5,3 kg
Material: laminated chipboard

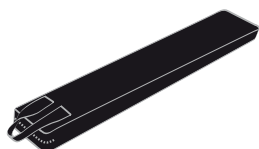

Art nr.: 2.11.07103-01
Weight: 0,24 kg
Material: nylon
Dimensions: 150 x 50 x 730 mm



Art nr.: 2.51.07012-01
Weight: 0,95 kg
Material: nylon
Dimensions: Ø 800 x 30 mm



Art nr.: 2.11.07130-01
Weight: 1,9 kg
Material: nylon, polypropylen,
foam filling
Dimensions: 270 x 230 x 850 mm

Art nr.	Description
2.50.12002	EUROtower 2, round including magnetic bars
2.51.02002	Top desk for ET, round
2.11.07130-01	Flight bag for structure, size 1, black
2.11.07103-01	Transport bag for straight mag. bars, max of 21 bars, black
2.51.07012-01	Transport bag round, black

Graphic panels for ET - 2, round

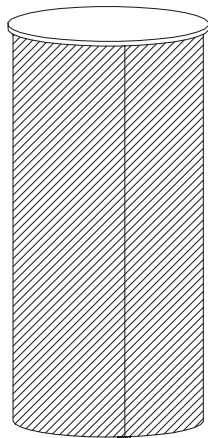

Art nr.: 2.53.12002-01
Weight: 1,89 kg
Material: PE

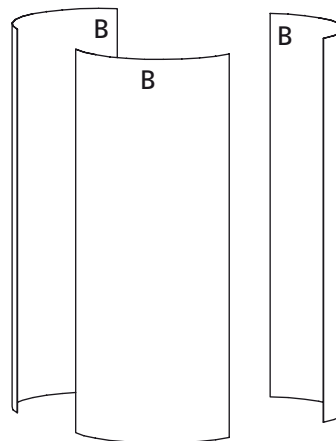

B: 733 x 1507 mm



Art nr.: 2.12.00230
Material: adhesive magnetic tape
Colour: black

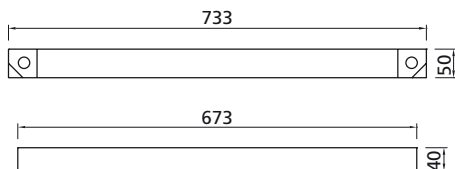

Art nr.: 2.52.09112

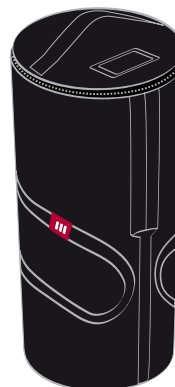

Art nr.: 2.11.07102-01
Weight: 2,48 kg
Material: nylon, polyethylen

Art nr.	Description
2.53.12002-01	Set of fully equipped graphic panels for ET - 2, round, incl. print
2.52.09112	Set of hangers and kickers for panels for ET round
2.11.07102-01	Flight bag for graphics, black
2.12.00230	Magnetic tape for panels, 30 m coil, magnetised A, Origin: EU

EUROtower 3, round

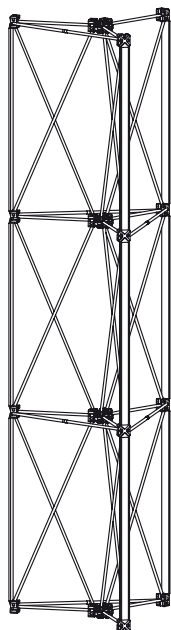

Art nr.: 2.50.13002
Weight: 5,36 kg
Material: aluminium alloy, eloxed

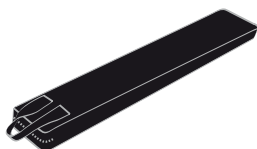
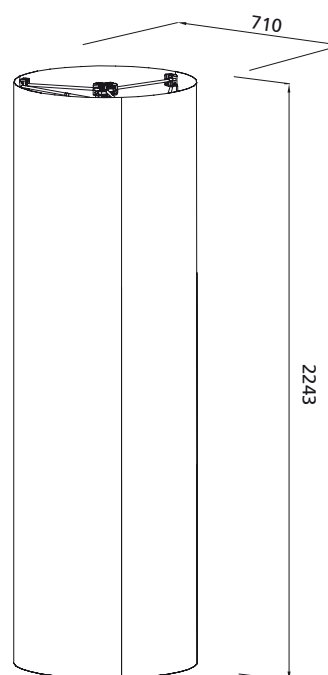

Art nr.: 2.11.07103-01
Weight: 0,24 kg
Material: nylon
Dimensions: 150 x 50 x 730 mm



Art nr.: 2.11.07130-01
Weight: 1,9 kg
Material: nylon, polypropylen,
foam filling
Dimensions: 270 x 230 x 850 mm

Art nr.	Description
2.50.13002	EUROtower 3, round including magnetic bars
2.11.07130-01	Flight bag for structure, size 1, black
2.11.07103-01	Transport bag for straight mag. bars, max of 21 bars, black

Graphic panels for ET - 3, round

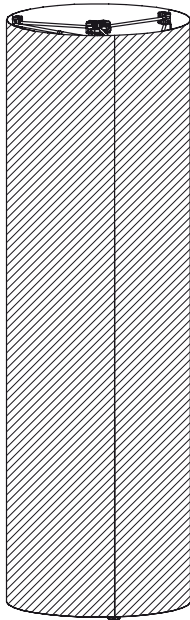

Art nr.: 2.53.13002-01
Weight: 2,82 kg
Material: PE

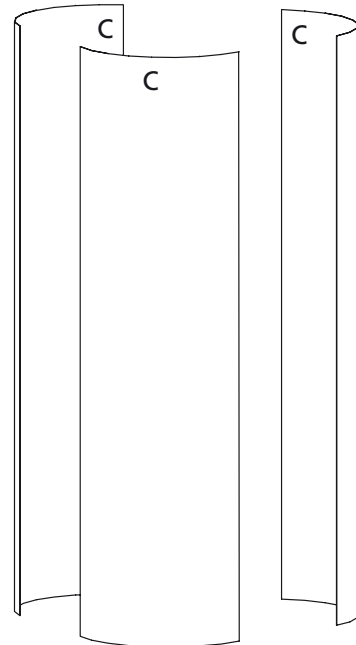

C: 733 x 2240 mm



Art nr.: 2.12.00230
Material: adhesive magnetic tape
Colour: black

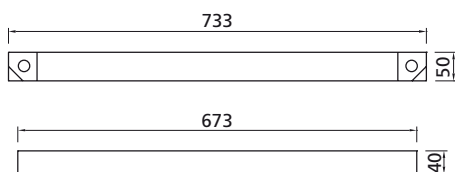

Art nr.: 2.52.09112

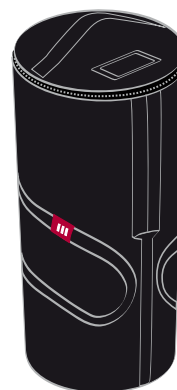

Art nr.: 2.11.07102-01
Weight: 2,48 kg
Material: nylon, polyethylen

Art nr.	Description
2.53.13002-01	Set of fully equipped graphic panels for ET - 3, round, incl. print
2.52.09112	Set of hangers and kickers for panels for ET round
2.11.07102-01	Flight bag for graphics, black
2.12.00230	Magnetic tape for panels, 30 m coil, magnetised A, Origin: EU

EUROtower 4, round

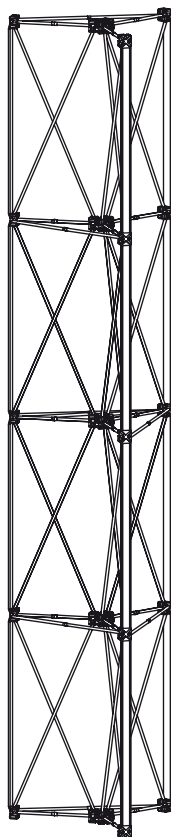

Art nr.: 2.50.14002
 Weight: 6,96 kg
 Material: aluminium alloy, eloxed

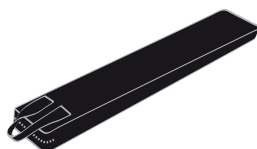
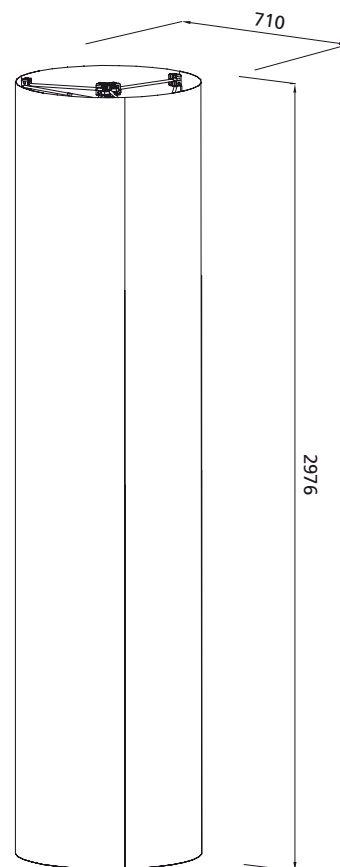

Art nr.: 2.11.07103-01
 Weight: 0,24 kg
 Material: nylon
 Dimensions: 150 x 50 x 730 mm



Art nr.: 2.11.07130-01
 Weight: 1,9 kg
 Material: nylon, polypropylen,
 foam filling
 Dimensions: 270 x 230 x 850 mm

Art nr.	Description
2.50.14002	EUROtower 4, round including magnetic bars
2.11.07130-01	Flight bag for structure, size 1, black
2.11.07103-01	Transport bag for straight mag. bars, max of 21 bars, black

Graphic panels for ET - 4, round

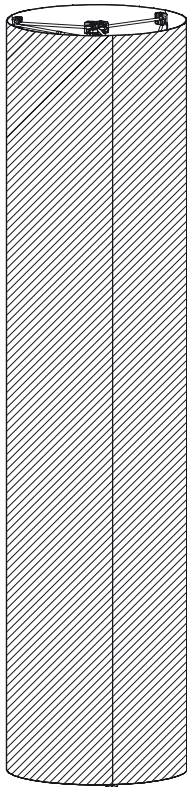

Art nr.: 2.53.14002-01
Weight: 3,84 kg
Material: PE

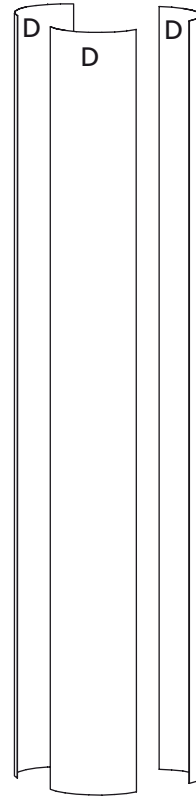

D: 733 x 2973 mm



Art nr.: 2.12.00230
Material: adhesive magnetic tape
Colour: black

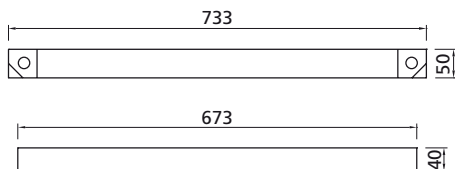

Art nr.: 2.52.09112

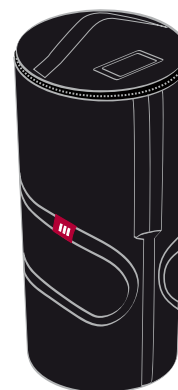

Art nr.: 2.11.07102-01
Weight: 2,48 kg
Material: nylon, polyethylen

Art nr.	Description
2.53.14002-01	Set of fully equipped graphic panels for ET - 4, round, incl. print
2.52.09112	Set of hangers and kickers for PVC panels for ET round
2.11.07102-01	Flight bag for graphics, black
2.12.00230	Magnetic tape for panels, 30 m coil, magnetised A, Origin: EU

Showcase

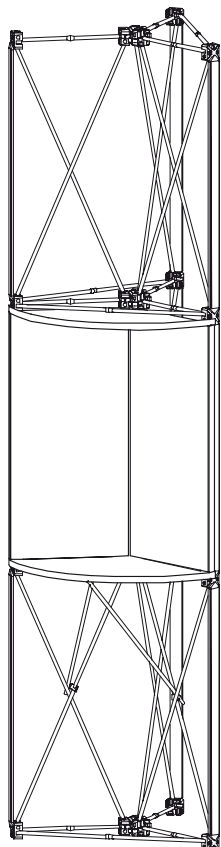

Art nr.: 2.11.05116
2.11.05117

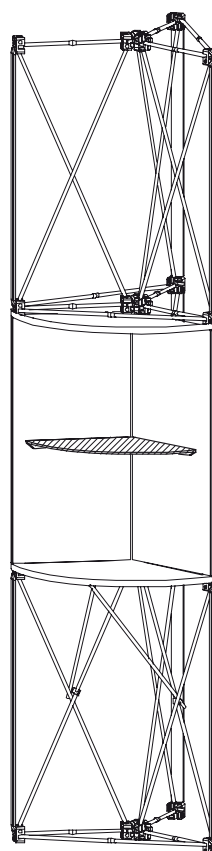

Art nr.: 2.11.03022

Art nr.	Description
2.11.05116	Showcase with lights for EUROtower round, incl. transport bag
2.11.03022	Shelf for showcase EUROtower, round, acrylic
2.11.05117	Showcase without lights for EUROtower round, incl. transport bag

Spare parts

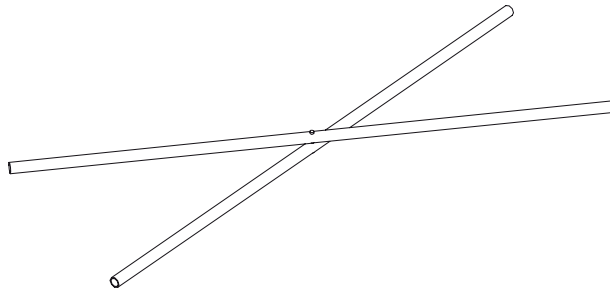

Art nr.: 2.51.09001
2.51.09002
Weight: 0,10 kg
Material: aluminium alloy, elloxed

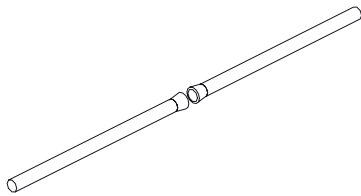

Art nr.: 2.51.09005
Weight: 0,40 kg
Material: aluminium alloy, elloxed

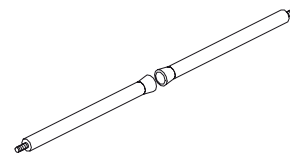

Art nr.: 2.51.09003
2.51.09004
Weight: 0,40 kg
Material: aluminium alloy, elloxed

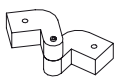

Art nr.: 2.51.09006
Weight: 0,10 kg
Material: aluminium alloy, elloxed

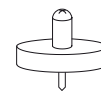

Art nr.: 2.51.09009
Weight: 0,05 kg
Material: aluminium alloy, elloxed

Art nr.	Description
2.51.09001	Aluminium scissors for ET, square
2.51.09002	Aluminium scissors for ET, round
2.51.09003	Magnetic lockers for the ET, square (pair)
2.51.09004	Magnetic lockers for the ET, round (pair)
2.51.09005	Magnetic outer lockers for the ET, round (pair)
2.51.09006	Joint for ET, round
2.51.09009	Insert for ET top desk

Mounting instructions, round towers

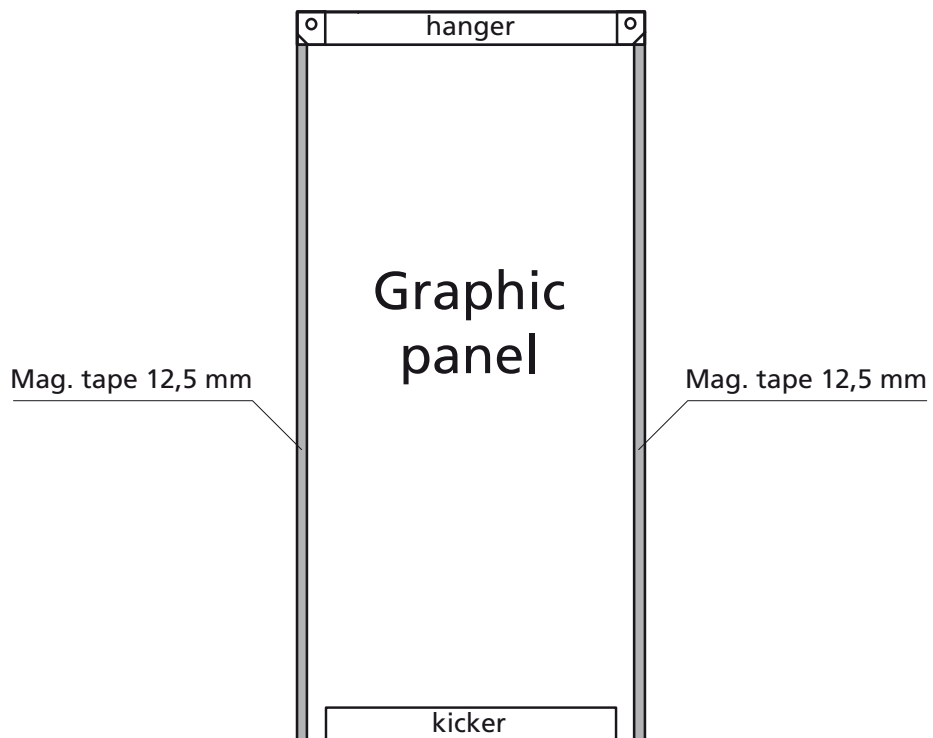

Mounting instructions, square towers

Front

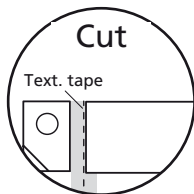
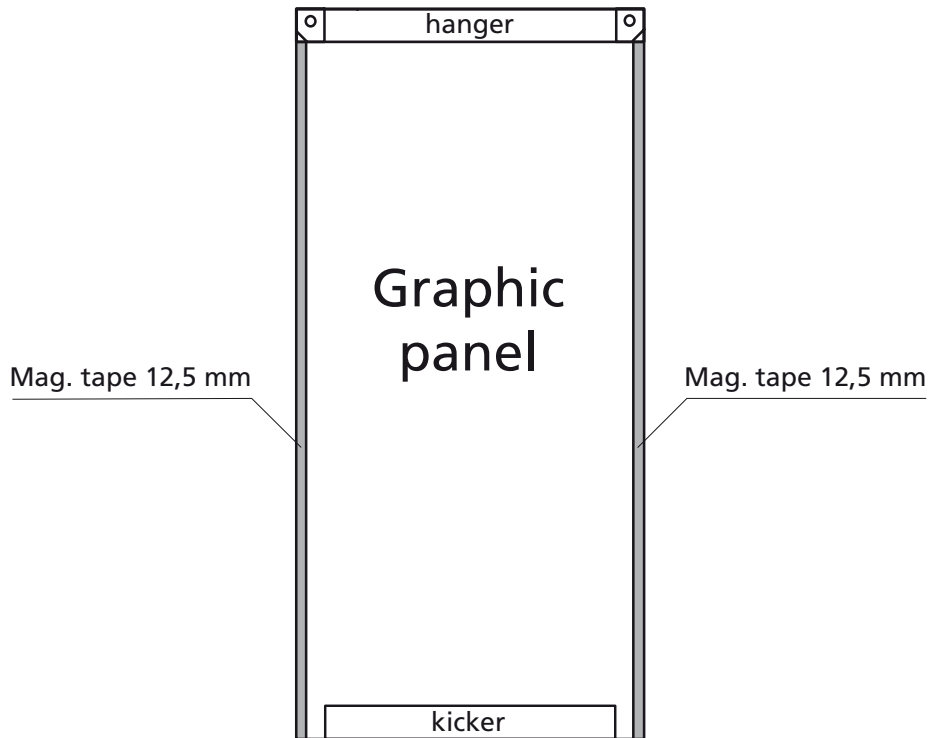

End cap

